

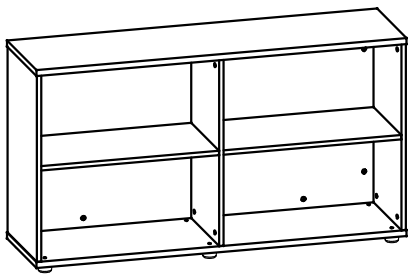

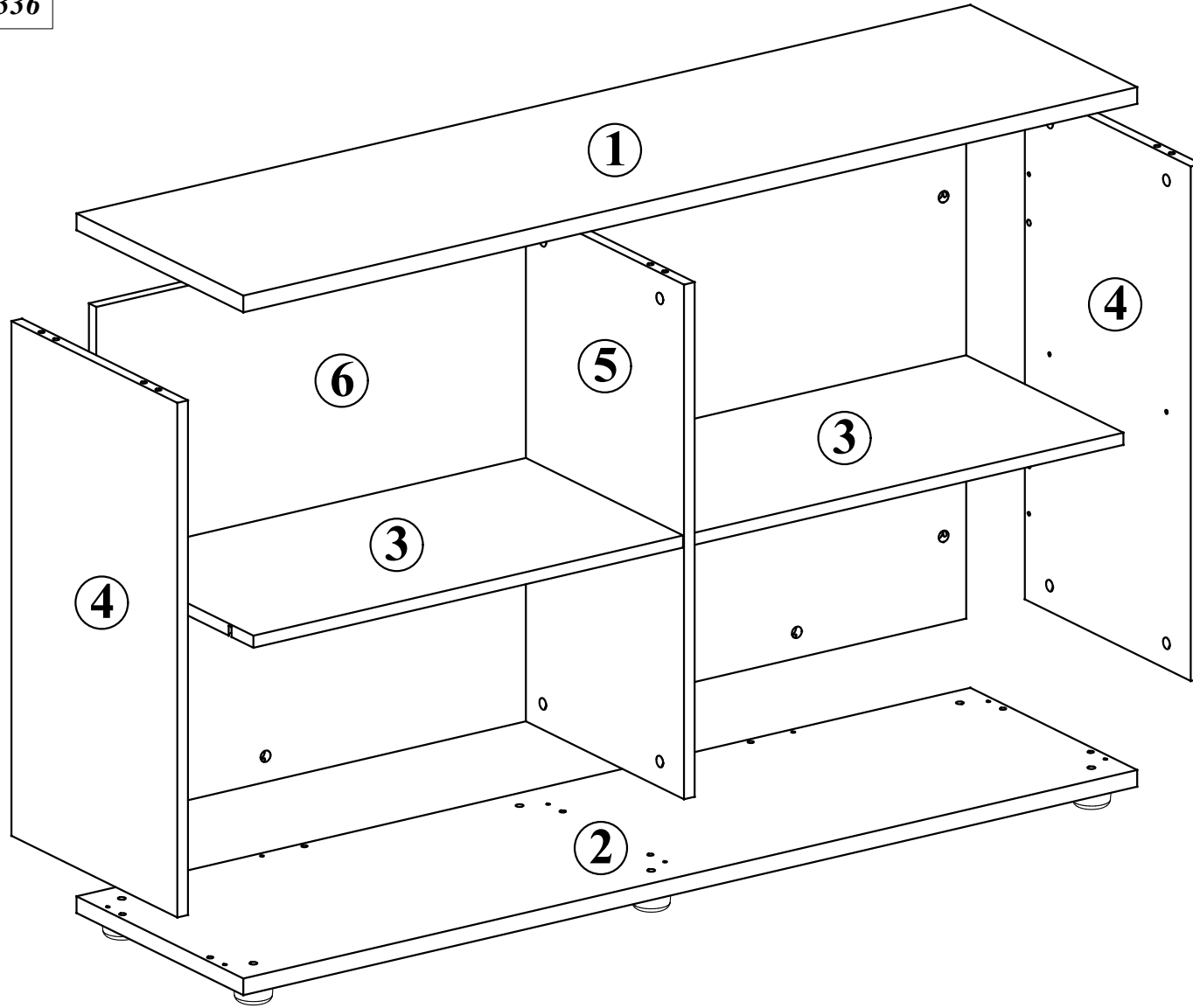

# ULCS 1336

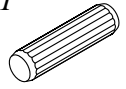
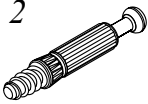
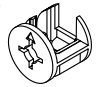
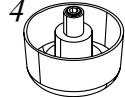

ULCS 1336

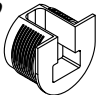
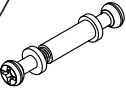

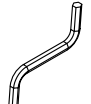
1		x20
2		x20
3		x20
4		x6
5		x20
6		x8
7		x2
8		x4
9		x1

**EAC**



